

Features

- Lead Free Finish/RoHS Compliant (NOTE 1)("P" Suffix designates RoHS Compliant. See ordering information)
- International standard package
- Heat transfer through aluminum oxide DBC ceramic isolated metal baseplate
- Glass passivated chip
- Simple Mounting

Applications

- Power Converters
- Lighting Control
- DC Motor Control and Drives
- Heat and temperature control

MCC Part Number	V _{RRM}	V _{RSM}
MT40CB16T1	1600V	1700V

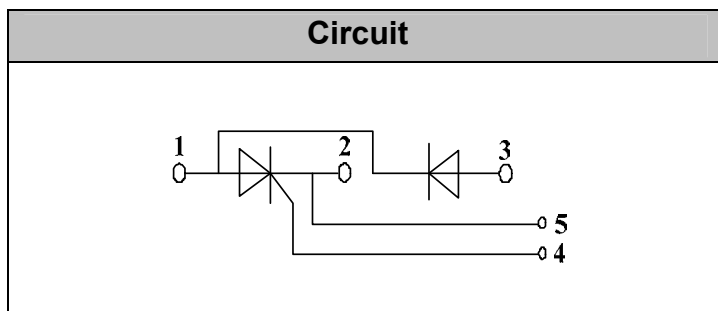
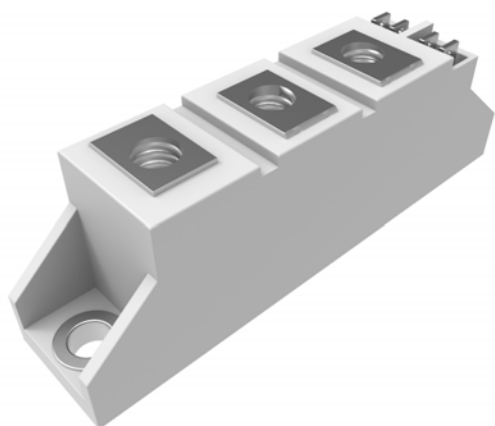

40 Amp THYRISTOR MODULE 1600 Volts

T1

DIM	INCHES		MM		NOTE
	MIN	MAX	MIN	MAX	
A	0.776	0.799	19.50	20.50	
B	1.169	1.193	29.50	30.50	
C	0.343	0.366	8.50	9.50	
D	0.323	0.346	8.00	9.00	
E	0.602	0.622	15.10	16.00	
F	0.224	0.248	5.50	6.50	
G	0.539	0.563	13.50	14.50	
H	0.657	0.681	16.50	17.50	
I	3.138	3.161	79.50	80.50	
J	3.650	3.673	92.50	93.50	
K	0.256		6.50		∅
L	0.421	0.445	10.50	11.50	
M	0.815	0.839	20.50	21.50	
O	0.579	0.602	14.50	15.50	
P	0.11X0.032		2.8X0.8		

◆Diode
Maximum Ratings

Symbol	Item	Conditions	Values	Units
I_D	Output Current(D.C.)	$T_c=85^\circ\text{C}$	40	A
I_{FSM}	Surge forward current	$t=10\text{mS } T_{vj}=45^\circ\text{C}$	1000	A
i^2t	Circuit Fusing Consideration		5000	A^2s
V_{isol}	Isolation Breakdown Voltage(R.M.S)	a.c.50HZ;r.m.s.;1min	3000	V
T_{vj}	Operating Junction Temperature		-40 to +125	$^\circ\text{C}$
T_{stg}	Storage Temperature		-40 to +125	$^\circ\text{C}$
M_t	Mounting Torque	To terminals(M5)	$3\pm 15\%$	Nm
M_s		To heatsink(M6)	$5\pm 15\%$	Nm
Weight	Module (Approximately)		100	g

Thermal Characteristics

Symbol	Item	Conditions	Values	Units
$R_{th(j-c)}$	Thermal Impedance, max.	Junction to Case	0.33	$^\circ\text{C/W}$
$R_{th(c-s)}$	Thermal Impedance, max.	Case to Heatsink	0.10	$^\circ\text{C/W}$

Electrical Characteristics

Symbol	Item	Conditions	Values			Units
			Min.	Typ.	Max.	
V_{FM}	Forward Voltage Drop, max.	$T=25^\circ\text{C } I_F=200\text{A}$			1.95	V
I_{RRM}	Repetitive Peak Reverse Current, max.	$T_{vj}=25^\circ\text{C } V_{RD}=V_{RRM}$ $T_{vj}=125^\circ\text{C } V_{RD}=V_{RRM}$		≤ 0.5 ≤ 6		mA mA

◆Thyristor

Maximum Ratings

Symbol	Item	Conditions	Values	Units
I_{TAV}	Average On-State Current	Sine 180°; $T_c=85^\circ\text{C}$	40	A
I_{TSM}	Surge On-State Current	$T_{VJ}=45^\circ\text{C}$ $t=10\text{ms}$, sine $T_{VJ}=125^\circ\text{C}$ $t=10\text{ms}$, sine	1000 850	A
i^2t	Circuit Fusing Consideration	$T_{VJ}=45^\circ\text{C}$ $t=10\text{ms}$, sine $T_{VJ}=125^\circ\text{C}$ $t=10\text{ms}$, sine	5000 3600	A^2s
Visol	Isolation Breakdown Voltage(R.M.S)	a.c.50HZ;r.m.s.;1min	3000	V
T_{vj}	Operating Junction Temperature		-40 to +125	$^\circ\text{C}$
T_{stg}	Storage Temperature		-40 to +125	$^\circ\text{C}$
M_t	Mounting Torque	To terminals(M5)	$3 \pm 15\%$	Nm
M_s		To heatsink(M6)	$5 \pm 15\%$	Nm
di/dt	Critical Rate of Rise of On-State Current	$T_{VJ}=T_{VJM}$, $2/3V_{DRM}$, $I_G=500\text{mA}$ $T_r < 0.5\mu\text{s}$, $t_p > 6\mu\text{s}$	150	A/ μs
dv/dt	Critical Rate of Rise of Off-State Voltage, min.	$T_J=T_{VJM}$, $2/3V_{DRM}$ linear voltage rise	1000	V/ μs
a	Maximum allowable acceleration		50	m/s^2

Thermal Characteristics

Symbol	Item	Conditions	Values	Units
$R_{th(j-c)}$	Thermal Impedance, max.	Junction to Case	0.65	$^\circ\text{C/W}$
$R_{th(c-s)}$	Thermal Impedance, max.	Case to Heatsink	0.20	$^\circ\text{C/W}$

Electrical Characteristics

Symbol	Item	Conditions	Values			Units
V_{TM}	Peak On-State Voltage, max.	$T=25^\circ\text{C}$ $I_T=200\text{A}$			1.95	V
I_{RRM}/I_{DRM}	Repetitive Peak Reverse Current, max. / Repetitive Peak Off-State Current, max.	$T_{VJ}=T_{VJM}$, $V_R=V_{RRM}$, $V_D=V_{DRM}$			15	mA
V_{TO}	On state threshold voltage	For power-loss calculations only ($T_{VJ}=125^\circ\text{C}$)			1.0	V
r_T	Value of on-state slope resistance. max	$T_{VJ}=T_{VJM}$			4.5	$\text{m}\Omega$
V_{GT}	Gate Trigger Voltage, max.	$T_{VJ}=25^\circ\text{C}$, $V_D=6\text{V}$			2.5	V
I_{GT}	Gate Trigger Current, max.	$T_{VJ}=25^\circ\text{C}$, $V_D=6\text{V}$			150	mA
V_{GD}	Non-triggering gate voltage, max.	$T_{VJ}=125^\circ\text{C}$, $V_D=2/3V_{DRM}$			0.25	V
I_{GD}	Non-triggering gate current, max.	$T_{VJ}=125^\circ\text{C}$, $V_D=2/3V_{DRM}$			6	mA
I_L	Latching current, max.	$T_{VJ}=25^\circ\text{C}$, $R_G=33\Omega$	300	600		mA
I_H	Holding current, max.	$T_{VJ}=25^\circ\text{C}$, $V_D=6\text{V}$	150	250		mA
tg _d	Gate controlled delay time	$T_{VJ}=25^\circ\text{C}$, $I_G=1\text{A}$, $di/dt=1\text{A}/\mu\text{s}$	1			μs
tq	Circuit commutated turn-off time	$T_{VJ}=T_{VJM}$	80			μs

Performance Curves

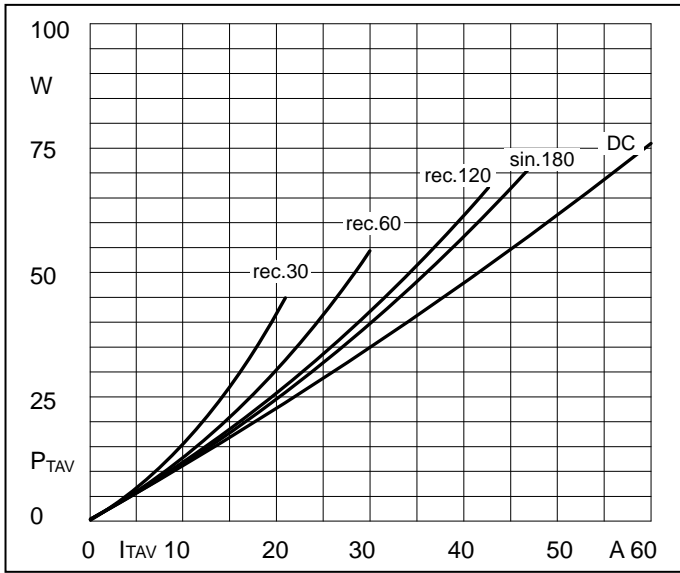

Fig1. Power dissipation

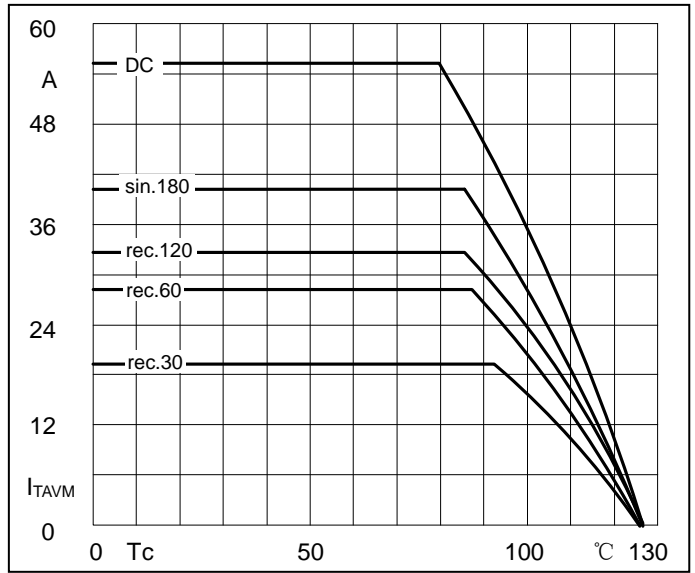

Fig2. Forward Current Derating Curve

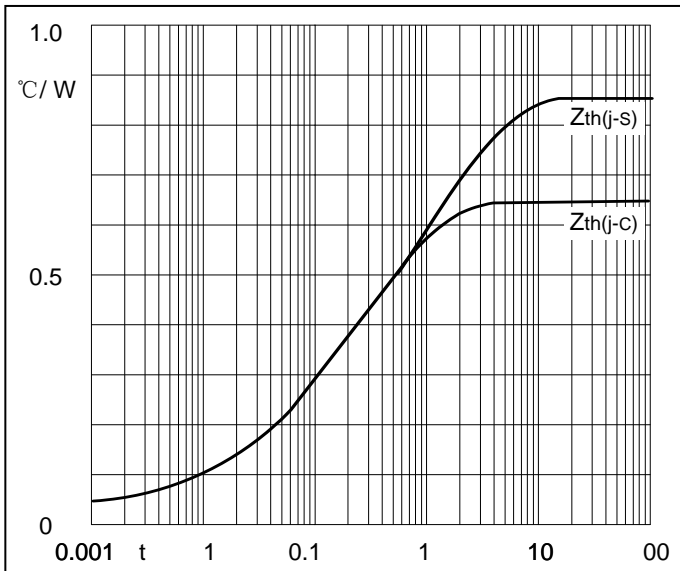

Fig3. Transient thermal impedance

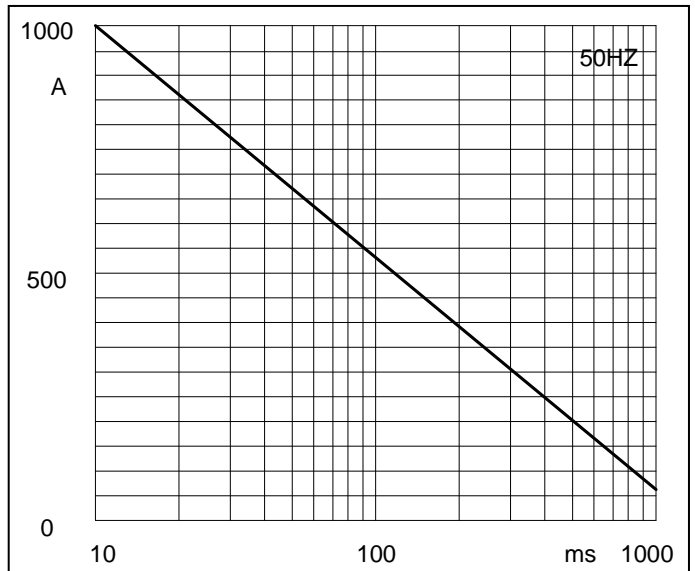

Fig4. Max Non-Repetitive Forward Surge Current

Performance Curves

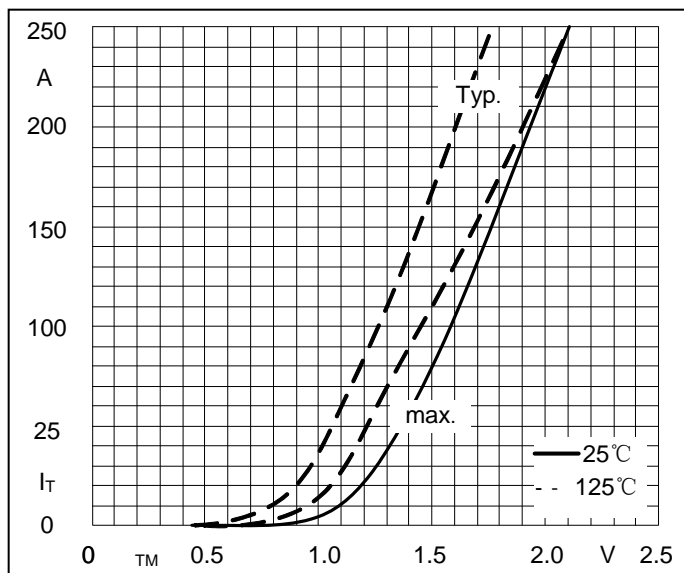

Fig5. Forward Characteristics

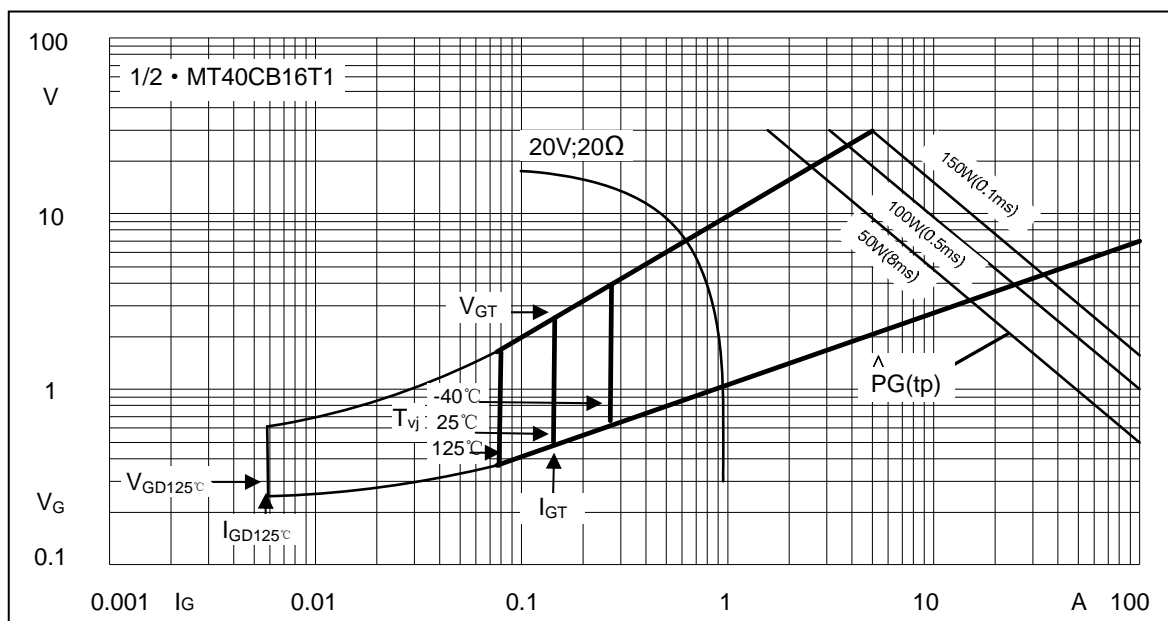

Fig6. Gate trigger Characteristics

Ordering Information

Device	Packing
Part Number-BP	Bulk: 10PCS/BOX ;100PCS/CTN

*****IMPORTANT NOTICE*****

Micro Commercial Components Corp. reserves the right to make changes without further notice to any product herein to make corrections, modifications, enhancements, improvements, or other changes. **Micro Commercial Components Corp.** does not assume any liability arising out of the application or use of any product described herein; neither does it convey any license under its patent rights, nor the rights of others. The user of products in such applications shall assume all risks of such use and will agree to hold **Micro Commercial Components Corp.** and all the companies whose products are represented on our website, harmless against all damages.

*****LIFE SUPPORT*****

MCC's products are not authorized for use as critical components in life support devices or systems without the express written approval of Micro Commercial Components Corporation.

*****CUSTOMER AWARENESS*****

Counterfeiting of semiconductor parts is a growing problem in the industry. Micro Commercial Components (MCC) is taking strong measures to protect ourselves and our customers from the proliferation of counterfeit parts. MCC strongly encourages customers to purchase MCC parts either directly from MCC or from Authorized MCC Distributors who are listed by country on our web page cited below. Products customers buy either from MCC directly or from Authorized MCC Distributors are genuine parts, have full traceability, meet MCC's quality standards for handling and storage. **MCC will not provide any warranty coverage or other assistance for parts bought from Unauthorized Sources.** MCC is committed to combat this global problem and encourage our customers to do their part in stopping this practice by buying direct or from authorized distributors.